

General Description

The AON3814 uses advanced trench technology to provide excellent $R_{DS(ON)}$, low gate charge and operation with gate voltages as low as 1.8V while retaining a 12V $V_{GS(MAX)}$ rating. It is ESD protected. This device is suitable for use as a uni-directional or bi-directional load switch, facilitated by its common-drain configuration.

Product Summary

V_{DS}	20V
I_D (at $V_{GS}=4.5V$)	6A
$R_{DS(ON)}$ (at $V_{GS} = 4.5V$)	< 17m Ω
$R_{DS(ON)}$ (at $V_{GS} = 4V$)	< 18.5m Ω
$R_{DS(ON)}$ (at $V_{GS} = 3.1V$)	< 23m Ω
$R_{DS(ON)}$ (at $V_{GS} = 2.5V$)	< 24m Ω

ESD Protected

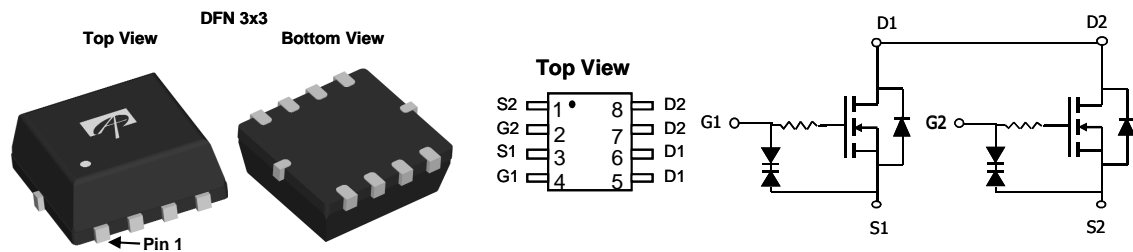

Absolute Maximum Ratings $T_A=25^\circ C$ unless otherwise noted

Parameter	Symbol	Maximum	Units
Drain-Source Voltage	V_{DS}	20	V
Gate-Source Voltage	V_{GS}	± 12	V
Continuous Drain Current ^F	I_D	$T_C=25^\circ C$	6
		$T_C=70^\circ C$	5.3
Pulsed Drain Current ^B	I_{DM}	40	A
Power Dissipation ^F	P_D	$T_C=25^\circ C$	2.5
		$T_C=70^\circ C$	1.6
Junction and Storage Temperature Range	T_J, T_{STG}	-55 to 150	$^\circ C$

Thermal Characteristics

Parameter	Symbol	Typ	Max	Units
Maximum Junction-to-Ambient ^A	$R_{\theta JA}$	40	50	$^\circ C/W$
Maximum Junction-to-Ambient ^A		Steady-State	75	95
Maximum Junction-to-Lead ^C	$R_{\theta JL}$	30	40	$^\circ C/W$

Electrical Characteristics (T_J=25°C unless otherwise noted)

Symbol	Parameter	Conditions	Min	Typ	Max	Units
STATIC PARAMETERS						
BV _{DSS}	Drain-Source Breakdown Voltage	I _D =250μA, V _{GS} =0V	20			V
I _{DSS}	Zero Gate Voltage Drain Current	V _{DS} =20V, V _{GS} =0V T _J =55°C			1 5	μA
I _{GSS}	Gate-Body leakage current	V _{DS} =0V, V _{GS} = ±10V			10	μA
V _{GS(th)}	Gate Threshold Voltage	V _{DS} =V _{GS} , I _D =250μA	0.3	0.7	1.1	V
I _{D(ON)}	On state drain current	V _{GS} =4.5V, V _{DS} =5V	40			A
R _{DS(ON)}	Static Drain-Source On-Resistance	V _{GS} =4.5V, I _D =6A T _J =125°C		12.5	17	mΩ
				18.5	24	
		V _{GS} =4V, I _D =6A		12.9	18.5	mΩ
		V _{GS} =3.1V, I _D =6A		14	23	mΩ
		V _{GS} =2.5V, I _D =6A		15.6	24	mΩ
		V _{GS} =1.8V, I _D =6A		23		mΩ
g _{FS}	Forward Transconductance	V _{DS} =5V, I _D =6A		33		S
V _{SD}	Diode Forward Voltage	I _S =1A, V _{GS} =0V		0.6	1	V
I _S	Maximum Body-Diode Continuous Current				3.5	A
DYNAMIC PARAMETERS						
C _{iss}	Input Capacitance	V _{GS} =0V, V _{DS} =10V, f=1MHz	730	920	1100	pF
C _{oss}	Output Capacitance		110	155	200	pF
C _{riss}	Reverse Transfer Capacitance		45	75	105	pF
R _g	Gate resistance	V _{GS} =0V, V _{DS} =0V, f=1MHz		2.4		kΩ
SWITCHING PARAMETERS						
Q _g	Total Gate Charge	V _{GS} =4.5V, V _{DS} =10V, I _D =6A	8.8	11	13	nC
Q _{gs}	Gate Source Charge		1.6	2	2.4	nC
Q _{gd}	Gate Drain Charge		1.9	3.2	4.5	nC
t _{D(on)}	Turn-On DelayTime	V _{GS} =5V, V _{DS} =10V, R _L =1.7Ω, R _{GEN} =3Ω		0.3		μs
t _r	Turn-On Rise Time			0.6		μs
t _{D(off)}	Turn-Off DelayTime			7.9		μs
t _f	Turn-Off Fall Time			4.4		μs

A: The value of R_{θJA} is measured with the device mounted on 1in² FR-4 board with 2oz. Copper, in a still air environment with T_A=25° C. The value in any given application depends on the user's specific board design.

B: Repetitive rating, pulse width limited by junction temperature.

C: The R_{θJA} is the sum of the thermal impedance from junction to lead R_{θJL} and lead to ambient.

D: The static characteristics in Figures 1 to 6 are obtained using <300 μs pulses, duty cycle 0.5% max.

E: These tests are performed with the device mounted on 1 in² FR-4 board with 2oz. Copper, in a still air environment with T_A=25° C. The SOA curve provides a single pulse rating.

F: The power dissipation and current rating is based on the t ≤ 10s thermal resistance, and current rating is also limited by wire-bonding.

THIS PRODUCT HAS BEEN DESIGNED AND QUALIFIED FOR THE CONSUMER MARKET. APPLICATIONS OR USES AS CRITICAL COMPONENTS IN LIFE SUPPORT DEVICES OR SYSTEMS ARE NOT AUTHORIZED. AOS DOES NOT ASSUME ANY LIABILITY ARISING OUT OF SUCH APPLICATIONS OR USES OF ITS PRODUCTS. AOS RESERVES THE RIGHT TO IMPROVE PRODUCT DESIGN, FUNCTIONS AND RELIABILITY WITHOUT NOTICE.

TYPICAL ELECTRICAL AND THERMAL CHARACTERISTICS

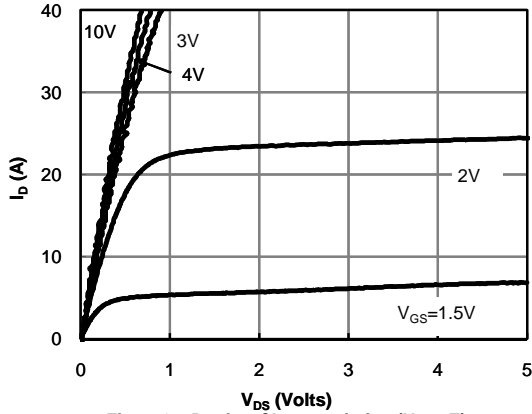

Figure 1: On-Region Characteristics (Note E)

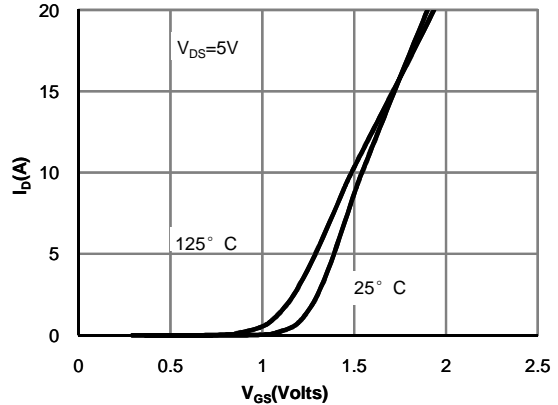

Figure 2: Transfer Characteristics (Note E)

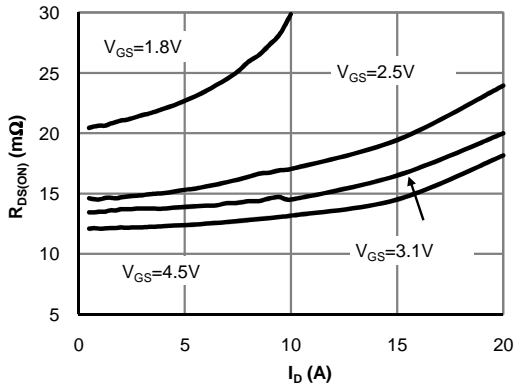

Figure 3: On-Resistance vs. Drain Current and Gate Voltage (Note E)

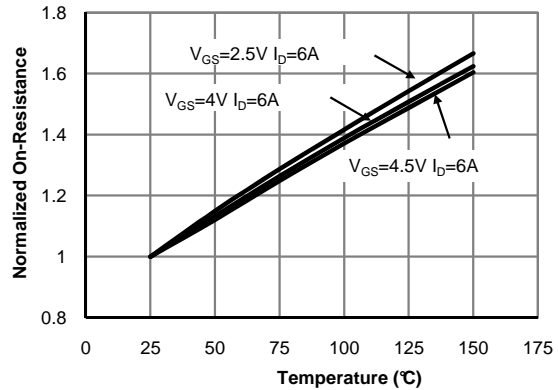

Figure 4: On-Resistance vs. Junction Temperature (Note E)

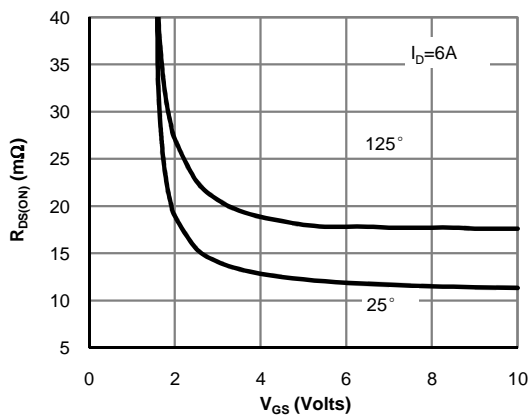

Figure 5: On-Resistance vs. Gate-Source Voltage (Note E)

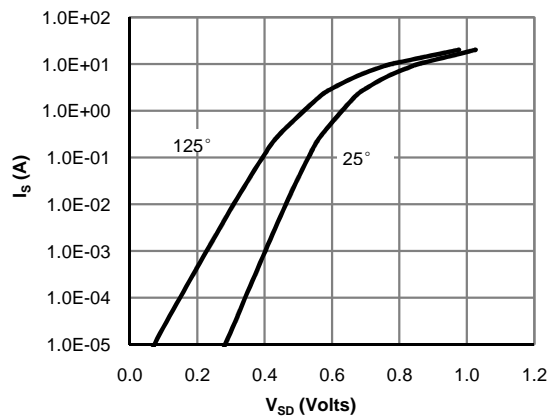

Figure 6: Body-Diode Characteristics (Note E)

TYPICAL ELECTRICAL AND THERMAL CHARACTERISTICS

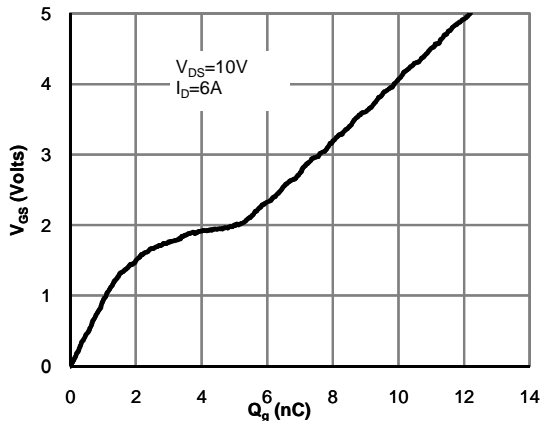

Figure 7: Gate-Charge Characteristics

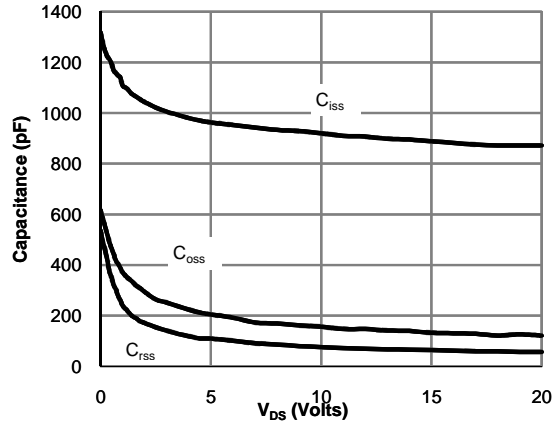

Figure 8: Capacitance Characteristics

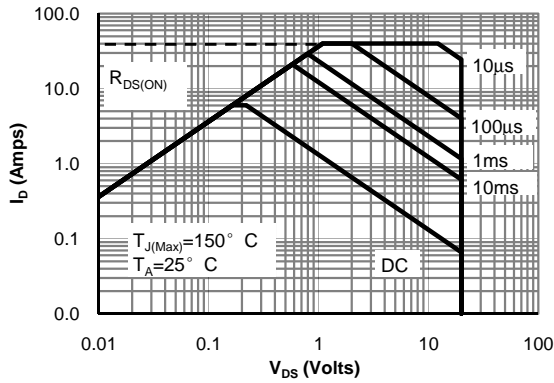

Figure 9: Maximum Forward Biased Safe Operating Area (Note F)

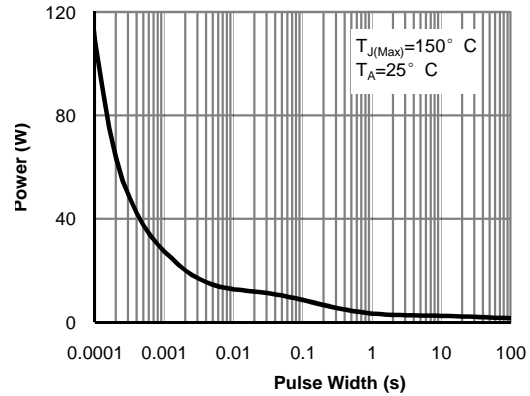

Figure 10: Single Pulse Power Rating Junction-to-Case (Note F)

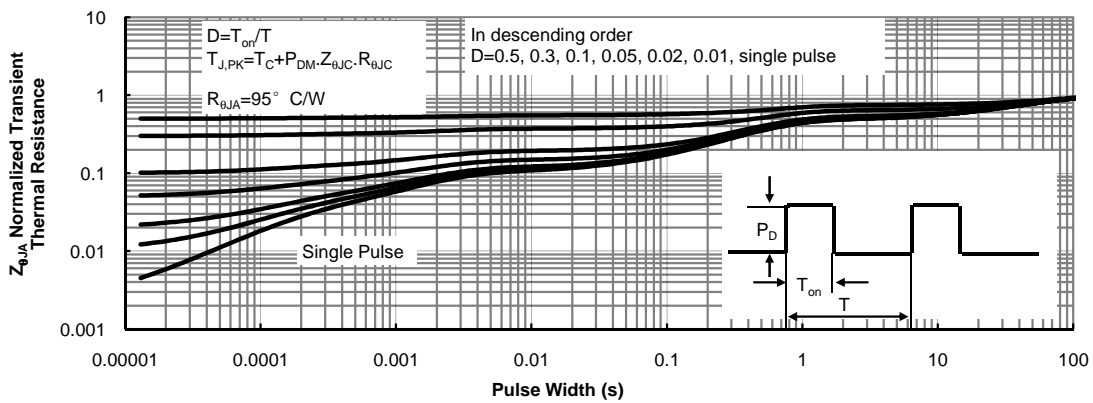
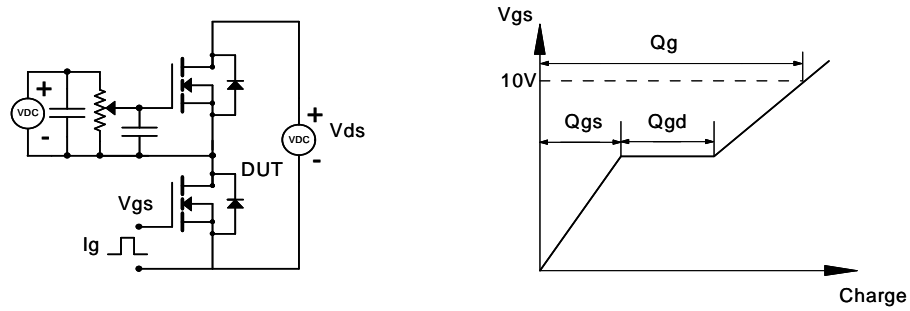
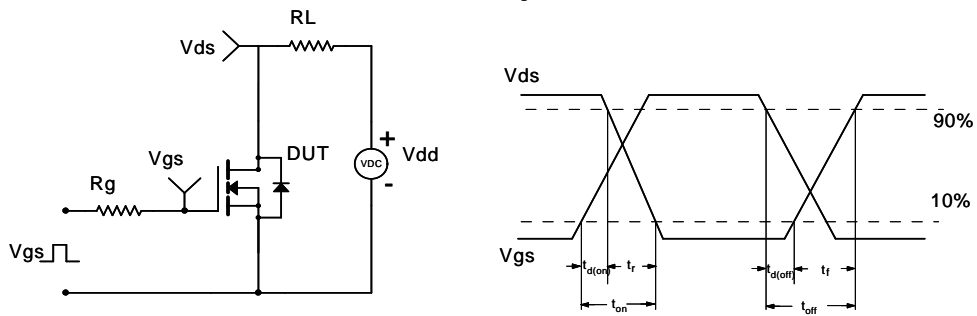

Figure 11: Normalized Maximum Transient Thermal Impedance (Note F)

Gate Charge Test Circuit & Waveform



Resistive Switching Test Circuit & Waveforms



Unclamped Inductive Switching (UIS) Test Circuit & Waveforms

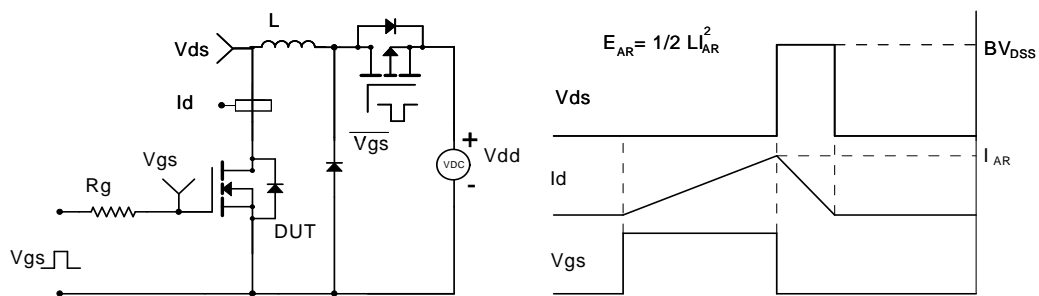

Diode Recovery Test Circuit & Waveforms

